



CARGOPORT / WORKPORT / ROCKPORT / PARCELPOR

# Rockport

QUALITY TRUCK BODIES



DELIVERING A HIGHER STANDARD

Rockport

# CARGO PORT



Vehicles shown with optional equipment.



## LOWEST FLOOR HEIGHT IN THE INDUSTRY

Built for the value minded operator whose focus is a well-constructed cargo box with functionality as the main aspect. Low entry height, mutiple side and rear door configurations, and optional shelving and cargo control packages make the Cargoport the logical choice for vocations that include multi-stop deliveries. The Cargoport affords the operator the flexibility to customize this unit creating a vehicle that is tailored to your specific needs.

### SPECIFICATIONS

### MEASUREMENTS

BODY SIZE	10' SRW	12' SRW	14' SRW	10' DRW	12' DRW	12' 6" DRW	14' DRW	15' DRW	16' DRW	17' DRW	18' DRW
Interior Height	6' 6"	6' 6"	6' 6"	6' 6"	6' 6"	6' 6"	6' 6"	6' 6"	6' 6"	6' 6"	6' 6"
(A) Wheel Base	139"	139"	159"	139"	139"	159"	159"	159"	177"	177"	191"
(B) Body Height	114"	114"	114"	114"	114"	114"	114"	114"	114"	114"	114"
(C) Truck Length	20'	22'	24'	20'	22'	22' 6"	24'	25'	26'	27'	28'
(D) Overall Body Length	11'	13'	15'	11'	13'	13' 6"	15'	16'	17'	18'	19'
(E) True Body Length	10'	12'	14'	10'	12'	12' 6"	14'	15'	16'	17'	18'
(F) Body Width	80"	80"	80"	96"	96"	96"	96"	96"	96"	96"	96"
(G) Load Width	78"	78"	78"	94.25"	94.25"	94.25"	94.25"	94.25"	94.25"	94.25"	94.25"
(H) Door Opening Width	71"	71"	71"	87.25"	87.25"	87.25"	87.25"	87.25"	87.25"	87.25"	87.25"
(I) Door Opening Height	72.5"	72.5"	72.5"	72.5"	72.5"	72.5"	72.5"	72.5"	72.5"	72.5"	72.5"
(J) Ground to Bumper	20"	20"	20"	20"	20"	20"	20"	20"	20"	20"	20"
(K) Ground to Floor	34"	33.5"	33.5"	33.5"	33.5"	33.5"	33.5"	33.5"	33.5"	33.5"	33.5"
(L) Bumper to Floor	14"	13.25"	13.25"	13.25"	13.25"	13.25"	13.25"	13.25"	13.25"	13.25"	13.25"
(M) Front Useable Space	56"	56"	76"	56"	56"	76"	76"	76"	95"	95"	109"
(N) Rear Useable Space	30"	54.5"	58.5"	30"	54.5"	41"	58.5"	70.5"	64"	76"	73"

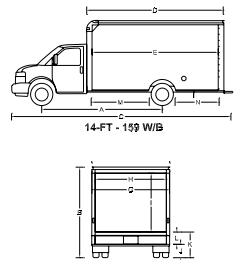

Rockport  
**WORKPORT**



Vehicles shown with optional equipment.



## ENCLOSED SERVICE BODY; RUGGED INSIDE AND OUT

A true workshop on wheels, the ergonomically designed Workport provides both an exceptional and functional way to service your customers. Stand-up interior height, heavy duty door hinges, integrated rear access ladders and Tuffply rubberized flooring are just a few standard features favored by our customers. The exterior compartments provide ease of access to cargo with the convenience of available power locks to keep your valuables secure at the push of a button. The flexible Workport can be tailored to your specific needs with available shelving, lighting, interior accessibility, cargo control and many other optional features that make this product truly unique to your line of work.

### SPECIFICATIONS

BODY SIZE	10' SRW	12' SRW	14' SRW	10' DRW	12' DRW	12' 6" DRW	14' DRW	16' DRW
Interior Height	6' 6"	6' 6"	6' 6"	6' 6"	6' 6"	6' 6"	6' 6"	6' 6"
(A) Wheel Base	139"	139"	159"	139"	139"	159"	159"	177"
(B) Body Height	121"	121"	121"	121"	121"	121"	121"	121"
(C) Truck Length	20'	22'	24'	20'	22'	22' 6"	24'	26'
(D) Overall Body Length	11'	13'	15'	11'	13'	13' 6"	15'	17'
(E) True Body Length	10'	12'	14'	10'	12'	12' 6"	14'	16'
(F) Body Width	80"	80"	80"	96"	96"	96"	96"	96"
(G) Compartment Height	42.25"	42.25"	42.25"	42.25"	42.25"	42.25"	42.25"	42.25"
(H) Compartment Depth	12.25"	12.25"	12.25"	22.5"	22.5"	22.5"	22.5"	22.5"
(I) Door Opening Width	49"	49"	49"	49"	49"	49"	49"	49"
(J) Door Opening Height	71.75"	71.75"	71.75"	71.75"	71.75"	71.75"	71.75"	71.75"
(K) Ground to Bumper	18"	18"	18"	18"	18"	18"	18"	18"
(L) Ground to Floor	32"	32"	32"	32"	32"	32"	32"	32"
(M) Bumper to Floor	14"	14"	14"	14"	14"	14"	14"	14"

### MEASUREMENTS

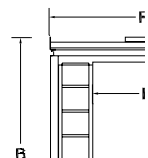
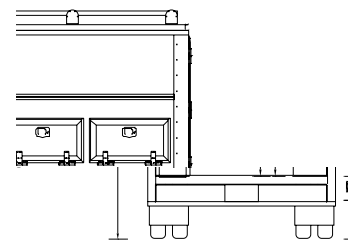
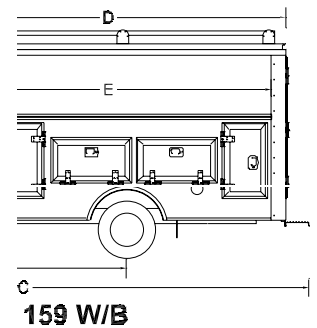

# Rockport ROCKPORT



## QUALITY OPTIONS COME STANDARD

With quality and flexibility at the forefront, Rockport has raised the bar higher with customer preferred innovations and enhancements built into every Rockport body. Customize “The Rock” with Aluminum or FRP sidewalls, Aluminum or Translucent roofing and various flooring options that include Laminated Hardwood with interlocking joints, AB Grade plywood for maximum strength, Extruded Aluminum Planks, and Steel or Aluminum Treadplate Overlay for easy clean up. Many other available options allow you to create “The Rock” in a way that best suits the needs of your specific application for many years of reliable service.

### MEASUREMENTS — SPECIFICATIONS

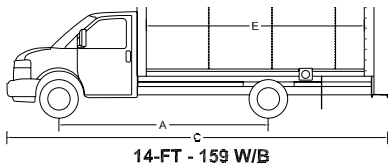

14-FT - 159 W/B

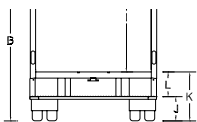

BODY SIZE	10' SRW	12' SRW	14' SRW	12' DRW	14' DRW	15' DRW	16' DRW	17' DRW	18' DRW
Interior Height	7'	7'	7'	7'	7'	7'	7'	7'	7'
(A) Wheel Base	139"	139"	139"	139"	159"	159"	159"	177"	177"
(B) Body Height	126"	126"	126"	126"	126"	126"	126"	126"	126"
(C) Truck Length	20' 1"	22' 1"	22' 1"	22' 7"	22' 7"	24' 1"	25' 1"	26' 1"	27' 1"
(D) Overall Body Length	11'	13'	13'	13' 6"	13' 6"	15'	16'	17'	18'
(E) True Body Length	10'	12'	12'	12' 6"	12' 6"	14'	15'	16'	17'
(F) Body Width	80"	80"	80"	96"	96"	96"	96"	96"	96"
(G) Load Width - ALUM	76.25"	76.25"	76.25"	92.25"	92.25"	92.25"	92.25"	92.25"	92.25"
(G) Load Width - FRP	78.34"	78.34"	78.34"	94.34"	94.34"	94.34"	94.34"	94.34"	94.34"
(H) Door Opening Width	71"	71"	87.25"	87.25"	87.25"	87.25"	87.25"	87.25"	87.25"
(I) Door Opening Height	78.5"	78.5"	78.5"	78.5"	78.5"	78.5"	78.5"	78.5"	78.5"
(J) Ground to Bumper	22"	22"	22"	22"	22"	22"	22"	22"	22"
(K) Ground to Floor	40.25"	40.25"	40.25"	40.25"	40.25"	40.25"	40.25"	40.25"	40.25"
(L) Bumper to Floor	18.25"	18.25"	18.25"	18.25"	18.25"	18.25"	18.25"	18.25"	18.25"

Vehicles shown with optional equipment.



## ADDITIONAL CUBIC FOOTAGE WITH LOWERED REAR DECK

Designed around a focus group of operators, the Parcelport was created from feedback within the Parcel Delivery industry. Operators shared their experiences about products they use daily and pinpointed what worked for them and what didn't. We listened, took notes and brought the Parcelport to market with standard features such as the Rocktop fiberglass wind fairing for increased fuel economy, reduced wind resistance and an overall clean, finished appearance, Tuffply rubberized flooring to keep cargo clean, dry and provides increased foot traction, translucent roofing for increased interior light, and an exclusive 29" aluminum rear drop floor for a lower ease of entry. Available side and rear door options and various shelving packages ensure that the Parcelport is the perfect fit for you.

### SPECIFICATIONS

### MEASUREMENTS

BODY SIZE	12' SRW	14' SRW	14' DRW	16' DRW
Interior Height	6' 6"	6' 6"	6' 6"	6' 6"
(A) Wheel Base	139"	159"	159"	177"
(B) Body Height	114"	114"	114"	114"
(C) Truck Length	22'	24'	24'	26'
(D) Overall Body Length	13'	15'	15'	17'
(E) True Body Length	12'	14'	14'	16'
(F) Body Width	80"	80"	96"	96"
(G) Load Width	78"	78"	94.25"	94.25"
(H) Door Opening Width	50"	50"	50"	50"
(I) Door Opening Height	81.5"	81.5"	81.5"	81.5"
(J) Ground to Bumper	18.5"	18.5"	18.5"	18.5"
(K) Ground to Floor	21.5"	21.5"	21.5"	21.5"
(L) Main Floor	10'	12'	12'	14'
(M) Drop Floor	2' 2"	2' 2"	2' 2"	2' 2"

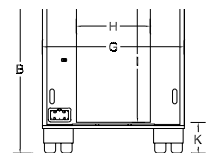
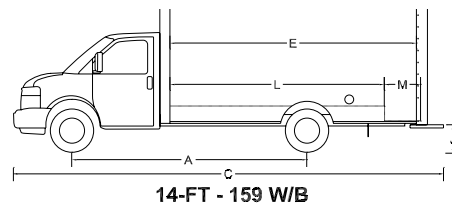

## ABOUT ROCKPORT QUALITY TRUCK BODIES

In 2002, Rockport Commercial Vehicles was founded in Elkhart, Indiana, as part of Forest River's vision to build a superior commercial vehicle. Our humble beginnings started with just a few cutaway chassis and has since become one of General Motors fastest growing bailment pools. Now Rockport has one of the most extensive selections of chassis configurations in the industry with inventories of Chevrolet & GMC cutaway chassis. Our key leadership team is comprised of experienced individuals that collectively share over 100 years of commercial body manufacturing experience. Each of our diverse and complimentary team experts provide a foundation that Rockport utilizes to create our customer-friendly designs & delivery schedule. Our financial strength with Berkshire Hathaway and Forest River is your assurance that we will be here to serve you for years to come. Understanding the importance of quality, we chose to locate our manufacturing facilities near our other existing Forest River cargo trailer manufacturing sites. These locations have experienced management resources, craftsman with a proven work ethic and a commitment to quality.



To learn more about Rockport Commercial Trucks and our products, and see how Rockport is delivering a higher standard, contact us today.

Call us at (888) 711-1600 or visit [rockporttrucks.com](http://rockporttrucks.com)

# Rockport

— QUALITY TRUCK BODIES —

**ROCKPORT COMMERCIAL VEHICLE DIVISION**

2323 Middlebury St. Elkhart, IN 46516

202 Industrial Drive Ocilla, GA 31774

Toll Free: 888-711-1600 Fax: 574-295-3974

[www.rockporttrucks.com](http://www.rockporttrucks.com)



Learn More  
Scan this barcode using  
a QR Reader on your  
smart phone to learn  
more about Forest River.



All information contained in this brochure is believed to be accurate at the time of publication. However, during the model year, it may be necessary to make revisions and Forest River, Inc., reserves the right to make all such changes without notice, including prices, colors, materials, equipment and specifications as well as the addition of new models and the discontinuance of models shown in this brochure. Therefore, please consult with your Forest River dealer and confirm the existence of any materials, design or specifications that are material to your purchase decision.  
©2020 Forest River Inc - All Rights Reserved.